



Note: The product images shown may change over time as products are updated.

### Part Number

**LCS2-3040P-A3U2-AMS**

### Features

Inductive Proximity Sensors are used in a wide variety of manufacturing operations where a metal target needs to be sensed. HTM Sensors inductive proximity sensors have a Lifetime Warranty, a CSA or UL approval, and a huge inventory for same-day shipping. For tougher applications where the sensors need more range to stay out of harm's way, or to withstand high temperatures, weld spatter, chemical exposure, oil or other rough environments, HTM Sensors has the widest range of proximity sensors on the market.

### Connection

#### PNP Normally Open

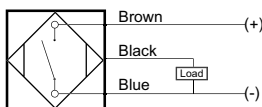

### Dimensions

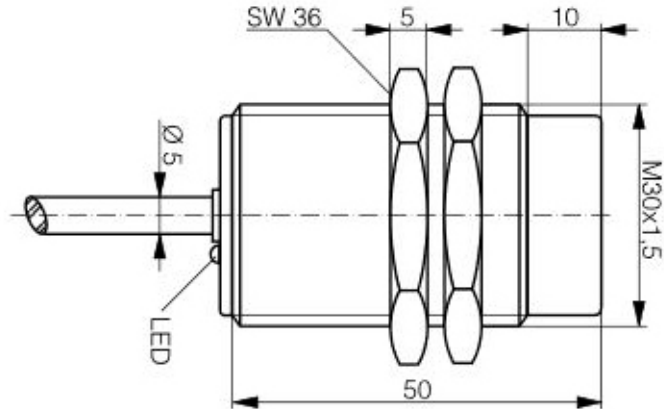

### Technical Data

Body Style	Cylindrical
Sensor Housing Material	V2A Stainless Steel
Sensor Face Material	V2A Stainless Steel
Mounting Style	Un-Shielded
Diameter	30 mm Threaded
Sensing Range:	40 mm
Output Type:	PNP
Output Function	Normally Open IO Link compatible
Connection	Pre-Leaded 3 Wire
Connector Type	2 m Cable
Operating Voltage	10-30 V DC
Switching Frequency	90 Hz
Operating Temperature	-25C to +85C
Current Consumption	<10 mA
IP Rating:	IP68
EMC Rating	IEC 60947-5-2 (7.2.3.1) 1Kv
Shock Rating:	EC 60947-5-2 / 7.9
Short Circuit Protected	Yes
Reverse Polarity Protected	Yes
Max Current	<200 mA
Leakage Current	<0.1 mA
Surge Current	N/A
Response Time	<30 mS
Hysteresis	0.15
Overload Trip Point	220 mA
Weld Field Immune	No
Weld Spatter Resistant	No
Body Length (mm)	50 mm