

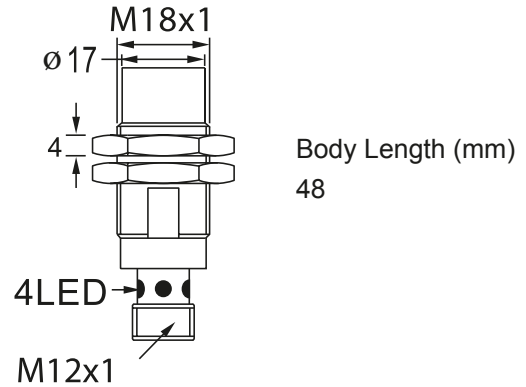

Note: The product images shown may change over time as products are updated.

Dimensions



Part Number

ECS2-1816C-ARS4

Features

Inductive Proximity Sensors are used in a wide variety of manufacturing operations where a metal target needs to be sensed. HTM Sensors inductive proximity sensors have a Lifetime Warranty, a CSA or UL approval, and a huge inventory for same-day shipping. For tougher applications where the sensors need more range to stay out of harm's way, or to withstand high temperatures, weld spatter, chemical exposure, oil or other rough environments, HTM Sensors has the widest range of proximity sensors on the market.

Connection

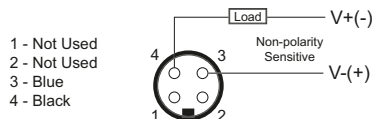

Technical Data

Body Style	Cylindrical
Sensor Housing Material	Stainless Steel SUS303
Sensor Face Material	1-Piece Stainless Steel
Mounting Style	Unshielded
Diameter	18 mm Threaded
Sensing Range:	16 mm range
Output Type:	DC 2-Wire Output
Output Function	Normally Open Output
Connection	4-Pin Connector
Connector Type	M12x1 Quick-Connect
Operating Voltage	10-60 VDC
Switching Frequency	150 Hz
Operating Temperature	-25 °C – +70 °C
Current Consumption	-
IP Rating:	IP68
EMC Rating	RFI>3V/m / EFT>1kV / ESD>4Kv (contact)
Shock Rating:	IEC 60497-5-2 Part 7.4.1&7.4.2
Short Circuit Protected	Yes
Reverse Polarity Protected	Yes
Max Current	100 mA
Leakage Current	<0.8 mA
Surge Current	-
Response Time	1 ms/1 ms
Hysteresis	<15%(Sr)
Overload Trip Point	>120 mA
Weld Field Immune	No
Weld Spatter Resistant	No
Body Length (mm)	48



In the USA: 1889 Maryland Ave., Niagara Falls, NY 14305
 In Canada: 3419 Mainway, Burlington, ON L7M 1A9
 Toll Free: 1-800-644-1756 • Fax: 888-283-2127
 service@htmsensors.com