

# DSTR6-5/4PA-3105

# Distribution Block

Single Occupancy

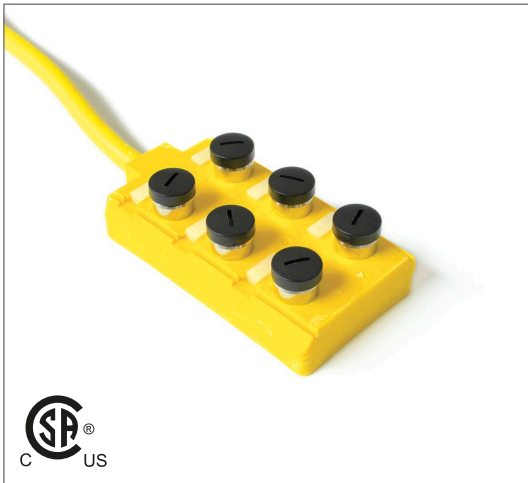

Note: The product images shown may change over time as products are updated.

## Diagram

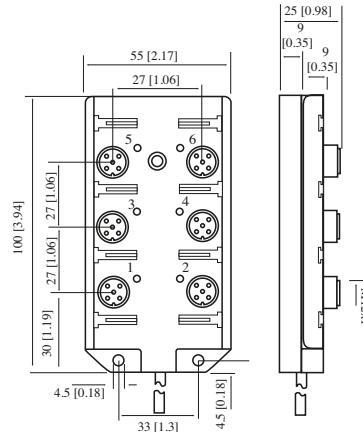

## Part Number

**DSTR6-5/4PA-3105**

## Features

4, 6 or 8 port distribution blocks make sensor connections easy and fast. Available in single occupancy ports or double occupancy ports for use with splitter cables to connect 2 sensors to each port. Available in 12-pin or 19-pin connectors or with a 5 m or 10 m prewired cable.

For additional information, contact HTM Sensors at 800-644-1756 or [service@htmsensors.com](mailto:service@htmsensors.com)

## Wiring

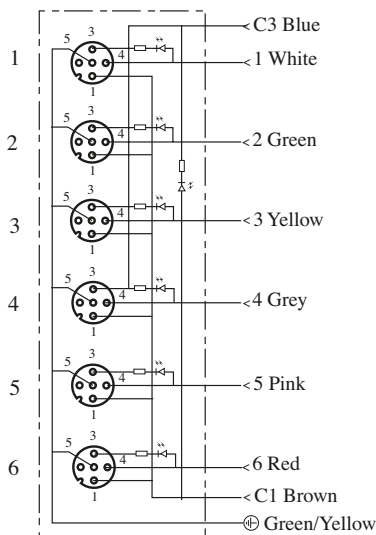

## Technical Data

Number of Ports	6
Port Size	M12 A Coded
Port Location	Top
LED Circuit	PNP
Home Run Connection	Pre-wired
Home Run Location	Side
Length	5 m
Jacket Type	PUR
Rated Voltage	10-30V DC
Rated Current	4 Amp Max per Port / 12 Amps Max per Block
IP Rating	IP67
Operating Temperature	-15 C to + 90 C
Vibration Rating	IEC-68-2-6
Shock Rating	IEC-68-27
Housing Material	Nylon 6/6
O-Ring	Viton
Contact Carrier	PUR
Home Run Connector Body	-



In the USA: 1889 Maryland Ave., Niagara Falls, NY 14305  
 In Canada: 3419 Mainway, Burlington, ON L7M 1A9  
 Toll Free: 1-800-644-1756 • Fax: 888-283-2127  
[service@htmsensors.com](mailto:service@htmsensors.com)

[htmsensors.com](http://htmsensors.com)