

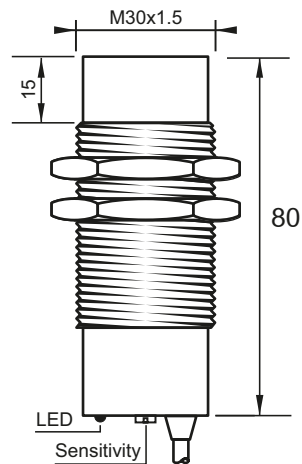

Note: The product images shown may change over time as products are updated.

Dimensions



Part Number

CCP2-3030N-B3U5

Features

- Capacitive sensors for the reliable detection of liquids, plastics, powders, pellets and pastes
- Available in plastic or stainless steel housings
- Connectable with a pre-wired cable of any length or with a quick-connector
- Available with PNP, NPN, AC or AC/DC output functions
- Mountable with a shielded or unshielded construction with adjustable sensitivity

Connection

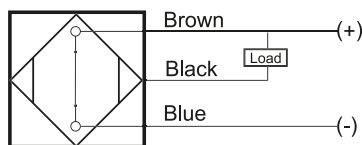

Technical Data

Sensing Type	Capacitive Sensor
Body Style	Cylindrical
Sensor Housing Material	PBT
Sensor Face Material	PBT
Mounting Style	Non-Shielded
Diameter	30 mm
Sensing Range:	2-30 mm
Output Type:	NPN
Output Function	Normally Closed
Connection	Pre-Wired Cable
Body Length	80
Operating Voltage	10-30 VDC
Switching Frequency	100 Hz
Operating Temperature	-25 °C - +70 °C
Overload Trip Point	350 mA
Hysteresis:	<15% (Sr)
IP Rating:	IP67
Shock Rating:	IEC 60947-5-2, Part 7.4.1/IEC 60947-5-2, Part 7.4.2
Short Circuit Protected	YES
Reverse Polarity Protected	YES
Connector Type	N_A
Current Consumption	<10 mA



In the USA: 1889 Maryland Ave., Niagara Falls, NY 14305
 In Canada: 3419 Mainway, Burlington, ON L7M 1A9
 Toll Free: 1-800-644-1756 • Fax: 888-283-2127
 service@htmsensors.com