

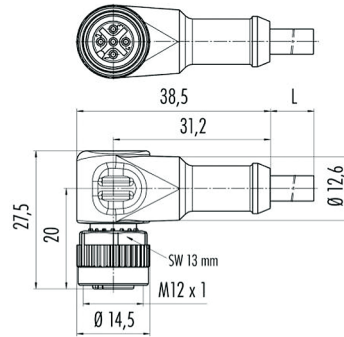

Note: The product images shown may change over time as products are updated.

Dimensions



Connection

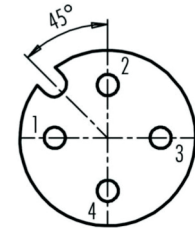

- 1 brown
- 2 white
- 3 blue
- 4 black

Part Number

R-FA4TZ-T6610

Features

- High performance TPE cables for automotive applications
- 10 Million flex rating for long-lasting performance
- Anti-vibration nuts for reliable connection
- PTFE coated nuts for spatter resistance
- Single-ended, double-ended and splitter versions available
- Ideal for use in weld cells where cables can get damaged

Cable Design

Technical Data

Connector Type	M12
Cable Type	Single
Connector A	-
Connector B	Female Angled
Length (m)	10 m
Locking System	Screw
Rated Current	4 A
Rated Voltage	250 V
Wire Gauge	4 x 22 AWG
Stranding	19 x 34
Contact Carrier	PUR
Molded Body	PUR
Contact Material	CuSn (Bronze)
Contact Plating	Au (Gold)
Jacket Type	TPE-E
Coupling Nut	PTFE Brass
Protection Class	IP68
Temperature Range	-25 °C to +105 °C

