

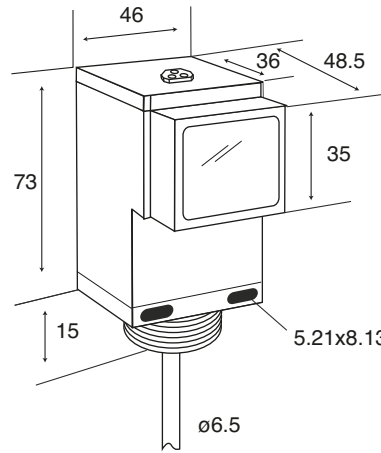

Note: The product images shown may change over time as products are updated.

Diagram



Part Number

RP74-T061MD-CY9P4UE

Features

Photoelectric sensors are used in virtually any manufacturing process with moving parts to detect products, machine parts, and a wide variety of moving objects.

For additional information, contact HTM Sensors at 800-644-1756 or service@htmsensors.com

Connection

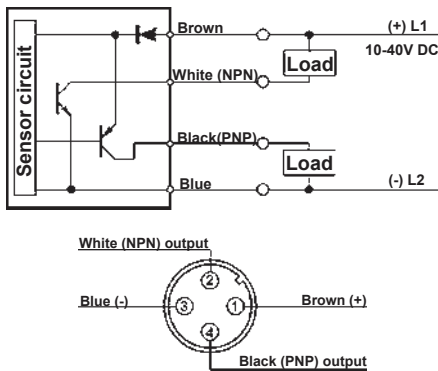

Technical Data

Sensing Range	61 m
Field of View	15°
Light Source	Infrared LED 880 nm
Indicator LEDs	Power: Yellow Output: Green Margin: Red
Output Type	1x NPN and 1x PNP Transistor Output
Supply Voltage	10-40VDC (Ripple <=10%)
Response Time	5 ms
Max. Load Current	250 mA
No Load Current	<30 mA
Max. Leakage Current	<10 uA
Operation Mode	Light On or Dark on Selectable via Switch
Housing Material	Glass Fiber Reinforced Plastic
Lens Material	Acrylic
Cover Gasket Material	Neoprene
IP Rating	IP67
Time Options	N/A
Ambient Operating Temperature	-25 °C to +55 °C
Storage Temperature	-40 °C to +70 °C
Relative Humidity	5%-95%
EMC Rating	IEC 60947-5-2, Parts 7.2.6.1.2.3 or RFI>3V/m(in30-1000MHZ), ETF>1KV, ESD>4KV(contact)
Vibration Resistance	IEC 60947-5-2, Part 7.4.2 (10-55HZ, 1mm amplitude in x,y and z directions for 30 min)
Shock Resistance	IEC-60947-5-2 Part 7.4.1 (30g, 11ms in x, y, and z directions for six times)
Cable or Connector	4-Pin M12 Male pigtailed QD



In the USA: 1889 Maryland Ave., Niagara Falls, NY 14305
 In Canada: 3419 Mainway, Burlington, ON L7M 1A9
 Toll Free: 1-800-644-1756 • Fax: 888-283-2127
service@htmsensors.com