

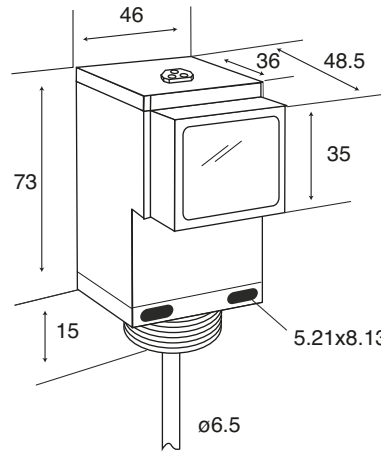

Note: The product images shown may change over time as products are updated.

Diagram



Part Number

RP74-L4870R-CY6C5L5-TP

Features

Photoelectric sensors are used in virtually any manufacturing process with moving parts to detect products, machine parts, and a wide variety of moving objects.

For additional information, contact HTM Sensors at 800-644-1756 or service@htmsensors.com

Connection



Technical Data

Sensing Range	4.87 m
Field of View	1.5°
Light Source	Red LED 660 nm
Indicator LEDs	Power: Yellow Output: Green Margin: Red
Output Type	SPDT Electromechanical Relay
Supply Voltage	20-240VAC/12-240VDC
Response Time	15 ms
Max. Load Current	10 A at 120VAC, 5 A at 240VAC
No Load Current	<30 mA
Max. Leakage Current	N/A
Operation Mode	Light On or Dark on Selectable via Switch
Housing Material	Glass Fiber Reinforced Plastic
Lens Material	Acrylic
Cover Gasket Material	Neoprene
IP Rating	IP67
Time Options	No Delay, On Delay, Off Delay, One Shot selectable via switch
Ambient Operating Temperature	-25 °C to +55 °C
Storage Temperature	-40 °C to +70 °C
Relative Humidity	5%-95%
EMC Rating	IEC 60947-5-2, Parts 7.2.6.1.2.3 or RFI>3V/m(in30-1000MHZ), ETF>1KV, ESD>4KV(contact)
Vibration Resistance	IEC 60947-5-2, Part 7.4.2 (10-55HZ, 1mm amplitude in x,y and z directions for 30 min)
Shock Resistance	IEC-60947-5-2 Part 7.4.1 (30g, 11ms in x, y, and z directions for six times)
Cable or Connector	5 m 6.1 mm dia PVC jacket 5 core x 0.5 mm≤



In the USA: 1889 Maryland Ave., Niagara Falls, NY 14305
 In Canada: 3419 Mainway, Burlington, ON L7M 1A9
 Toll Free: 1-800-644-1756 • Fax: 888-283-2127
service@htmsensors.com