

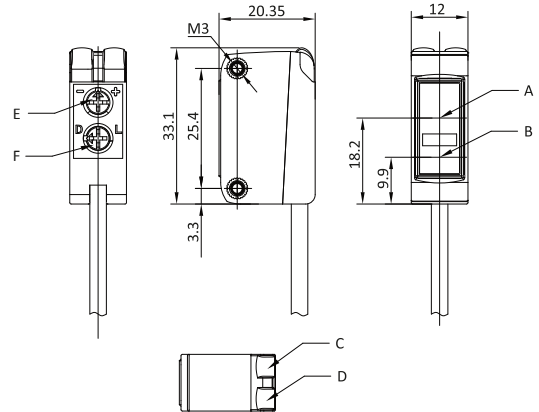

Note: The product images shown may change over time as products are updated.

Dimensions



Polarized retro-reflective
A: Receiver
B: Emitter
C: Output indicator
D: Steady state indicator
E: Distance adjustment knob
F: Adjustor for LO/DO

Part Number

H31-PRET-3000N-SA-M12-4P0.3

Features

Photoelectric sensors are used in virtually any manufacturing process with moving parts to detect products, machine parts, and a wide variety of moving objects.

For additional information, contact HTM Sensors at 800-644-1756 or service@htmsensors.com

Connection

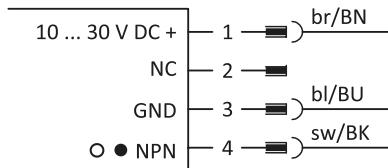

Technical Data

Sensing Range	5 m
Light Source	Red Laser (650 nm) Class 1
Light Spot Size	3 mm @ 500 mm, 8 mm @ 5m
Indicator LEDs	Output: Red Steady State: Green
IO-Link	No
Supply Voltage	10-30 V DC
Max. Load Current	<= 100 mA
No Load Current	<= 25 mA
Short Circuit Protection	Yes
Reverse Polarity Protection	Yes
Output Type	NPN
Operation Mode	Light On / Dark On Selectable by Switch
Switching Frequency	800 Hz
Sensitivity Adjustment	Yes
Housing Material	PC+PBT
Lens Material	PC
IP Rating	IP67
Timer Options	-
Ambient Operating Temperature	-20 C to +60 C
Vibration Resistance	EN 60068-2-32
Shock Resistance	EN 60068-2-27
Cable or Connector	0.3 m M12 4 Pin Pigtail

