

HTMTM
SENSORS

SA-80T-2A

0 to 200°C

SA-80T-4A

0 to 400°C

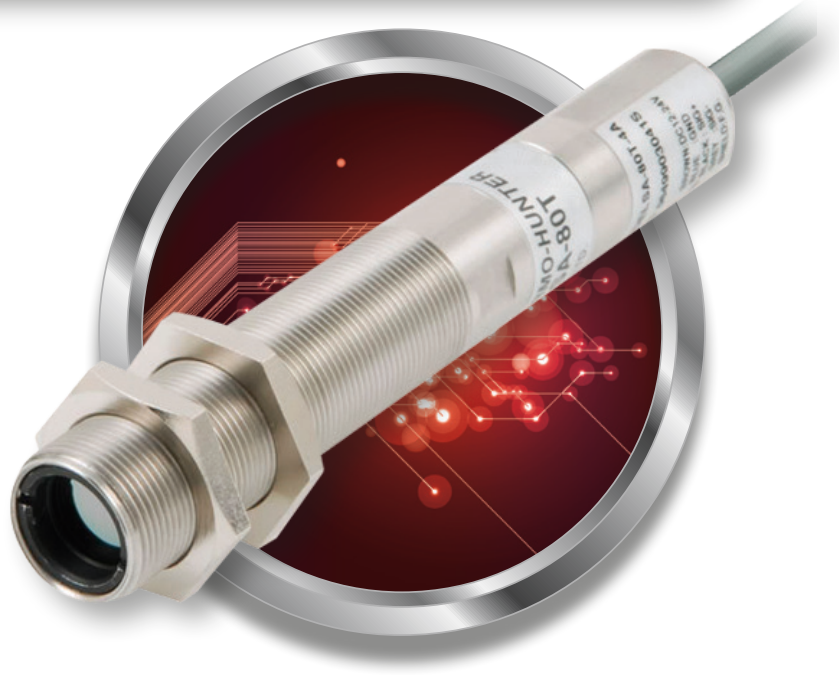

Features

- High-speed response time 100ms/ 90%
- Tough and Heavy-Duty
 - Waterproofing ability in compliance with IP67
 - High heat resistance up to 70°C of ambient temperature
 - High noise resistance and accurate temperature measurement with stable operation due to Stainless Steel Housing and silicon lens
- Cylindrical shape enabling installation in a limited space

Optical Specifications

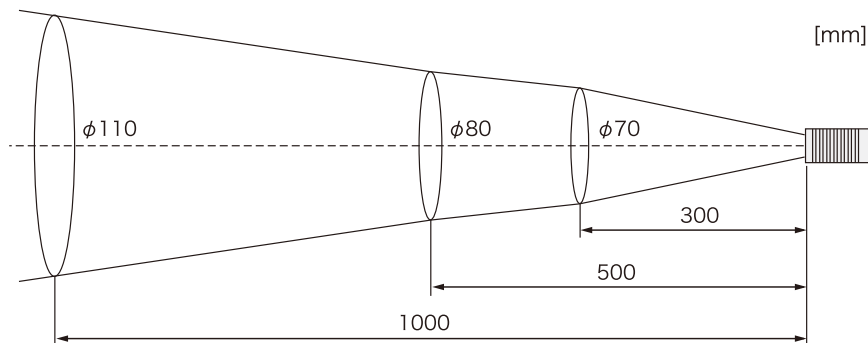

- ※ The optical resolution values stated above are at minimum 90% energy.
- ※ The size of measuring object should be sufficiently larger than the spot size.

M18 NON-CONTACT THERMO SENSORS SPECIFICATIONS

Specifications

Model	SA-80T-2A	SA-80T-4A
Temperature range	0 to 200°C	0 to 400°C
Optical resolution	φ80mm/500mm	
Sensing element/Spectral response	Thermopile/8 to 14μm	
System accuracy	0 to 200°C:±2°C 201 to 400°C:±1%	
Repeatability	±1°C of reading	
Response time	100ms/90%	
Temperature resolution	1°C	
Emissivity (ε)	0.95	
Analog output	4-20mA	
Power supply	12-24VDC ±10%/Max 70mA	
Ambient temperature	0 to 70°C	
Relative humidity	35 to 85%Rh (non-condensing)	
Storage temperature	-20 to 70°C	
Protection class	IP67	
Vibration resistance	10 to 55Hz, amplitude 1.5mm, 2hours each in any axis	
Material	Stainless steel/aluminium	
Weight	350g	

*Specifications subject to change without notice.

Dimensions

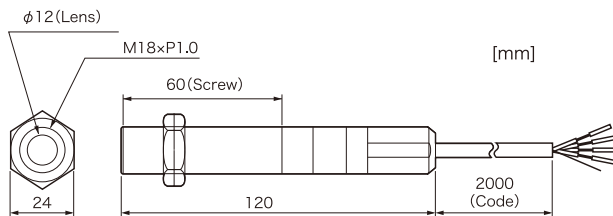

Connection Diagram

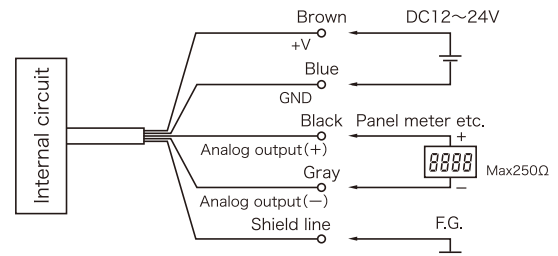

Applications

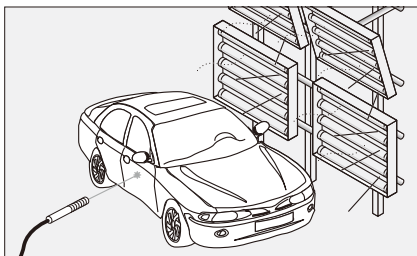

For checking dehydration temperature
in baking finishing

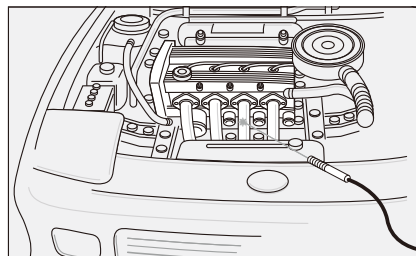

For checking abnormal heat in engine / drive

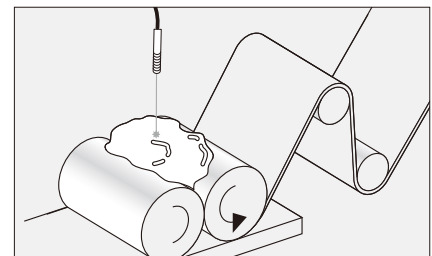

For checking temperature in processing /
forming management



In Canada: 3419 Mainway, Burlington, ON L7M 1A9
 In the USA: 1889 Maryland Ave., Niagara Falls, NY 14305
 Toll Free: 1-800-644-1756
 service@htmsensors.com