

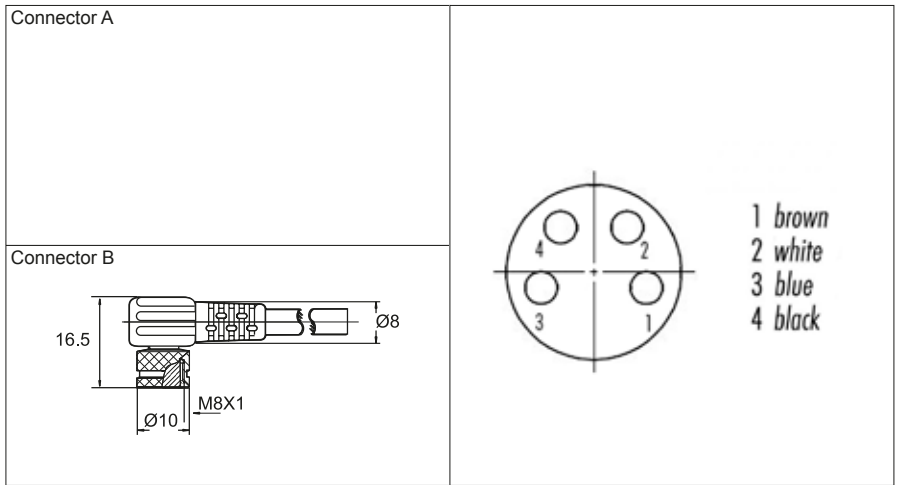

Note: The product images shown may change over time as products are updated.

Dimensions **Connection**



Part Number

C-FA4TZ-V075

Features

HTM Sensors stocks thousands of sensor cables for convenient same-day-shipping. Standard M8 and M12 cables have the best prices in the industry and are always available and in stock for customer requirements.

New advances in sensor cables allow for extended durability and longevity in the harshest environments.

Technical Data

Cable Type	Single Ended Cable
Connector A	
Connector B	M8 A-Coded Female Angled
Length (m)	5 m
Locking System	Screw Lock
Rated Current	4A
Rated Voltage	60 VAC / 75 VDC
Wire Gauge	24 AWG
Stranding	0.1x32
Contact Carrier	TPU
Molded Body	TPU
Contact Material	CuSn
Contact Plating	Au
Jacket Type	PVC
Coupling Nut	Nickel Plated Brass
Protection Class	IP 68
Temperature Range	- 25 C to + 90 C

